

Filter Cartridges  
Cartridge Filter Housings



*Powering Business Worldwide*

In September 2005 Eaton Corporation acquired the industrial filtration business of Hayward Industries, Inc. The Hayward filtration business has been integrated into Eaton's Fluid Power Group as the Filtration Division. In addition Eaton Corporation purchased in September 2006 the Ronningen Petter industrial fine filtration business from Dover Resources. Eaton's Filtration Division is a global leader in products that include pipeline strainers, bag filtration systems, gas/liquid separators, automatic filtration systems for industrial and commercial customers worldwide. Primary markets include general industrial, petro-chemical, automotive, pharmaceutical, oil & gas, pulp & paper, food and beverage, power utilities, marine, and water.

## BAG FILTRATION SYSTEMS

Eaton's Bag Filter Housings and Filter Bags are used by industries around the world and are manufactured worldwide to global standards. Customers can choose from a complete line of single and multi-bag filter housings designed to meet the needs of the most demanding applications. The choice of single bag filter housings range from those suitable for exacting absolute filtration applications to high quality housings designed especially for cost sensitive applications... and everything in between. Multi-bag housings that accommodate up to 36 individual filter bags for flow rates of up to 1000 m<sup>3</sup>/h are available in a number of different designs. Eaton offers a full range of Filter Bags...more than 1500 choices in all. From economical sewn filter bags for standard applications to welded, multilayered bags for demanding applications.

## CARTRIDGE FILTRATION SYSTEMS

Eaton's broad range of filter cartridges gives customers wide flexibility in choosing filtration solutions. Available are nominal and absolute rated melt blown, string wound, resin bonded and activated carbon cartridges, filter modules, stainless steel and plastic filter housings.

## PIPELINE STRAINERS

Eaton's Pipeline Strainers are used by industrial and commercial customers to protect their process piping equipment by removing debris from the liquid that flows through pipelines. Products include automatic self-cleaning strainers as well as manual, duplex, simplex, and Y strainers. Both cast and fabricated type strainers are made in standard configurations to

meet the needs of most applications. For unique, complex, or specialized applications, a Pipeline Strainer can be designed and manufactured to meet the exact requirements of the application with no compromises.

## AUTOMATIC FILTER SYSTEMS

The wide Ronningen-Petter range consists of automatic self-cleaning filtration systems. Solutions can be offered from internal or external backwashing systems for the filtration of water and aqueous media to mechanically cleaned filters systems for high viscous liquids. The filters are always sized to the customer's individual applications and needs.

## GAS/LIQUID SEPARATORS

Eaton's Gas/Liquid Separators protect expensive system components, such as turbines, by removing potentially damaging moisture and particulate matter from air, gas, and steam lines.

## COMMITMENT TO GLOBAL MARKETS

Eaton's Bag Filtration Systems, Cartridge Filtration Systems, Pipeline Strainers, and Gas/Liquid Separators have each been developed into a global product line which is manufactured worldwide in multiple locations to a common design standard yet in compliance with local code requirements. This lets Eaton customers worldwide choose the pipeline strainer, bag filter, or gas/liquid separator that meets their exact requirements without compromise. Local sales and technical support specialists are always available to review the needs of an application with the customer and recommend specific solutions.

## EATON CORPORATION

Eaton is a diversified industrial manufacturer with sales of \$ 15.4 billion in 2008. Eaton is a global leader in electrical systems and components for power quality, distribution, and control; fluid power systems and services for industrial, mobile, and aircraft equipment; intelligent truck drivetrain systems for safety and fuel economy; and automotive engine air management systems, powertrain solutions, and specialty controls for performance, fuel economy, and safety. Eaton has 70,000 employees and sells products to customers in more than 150 countries. For more information, visit [www.filtration.eaton.com](http://www.filtration.eaton.com).

# FILTER CARTRIDGES

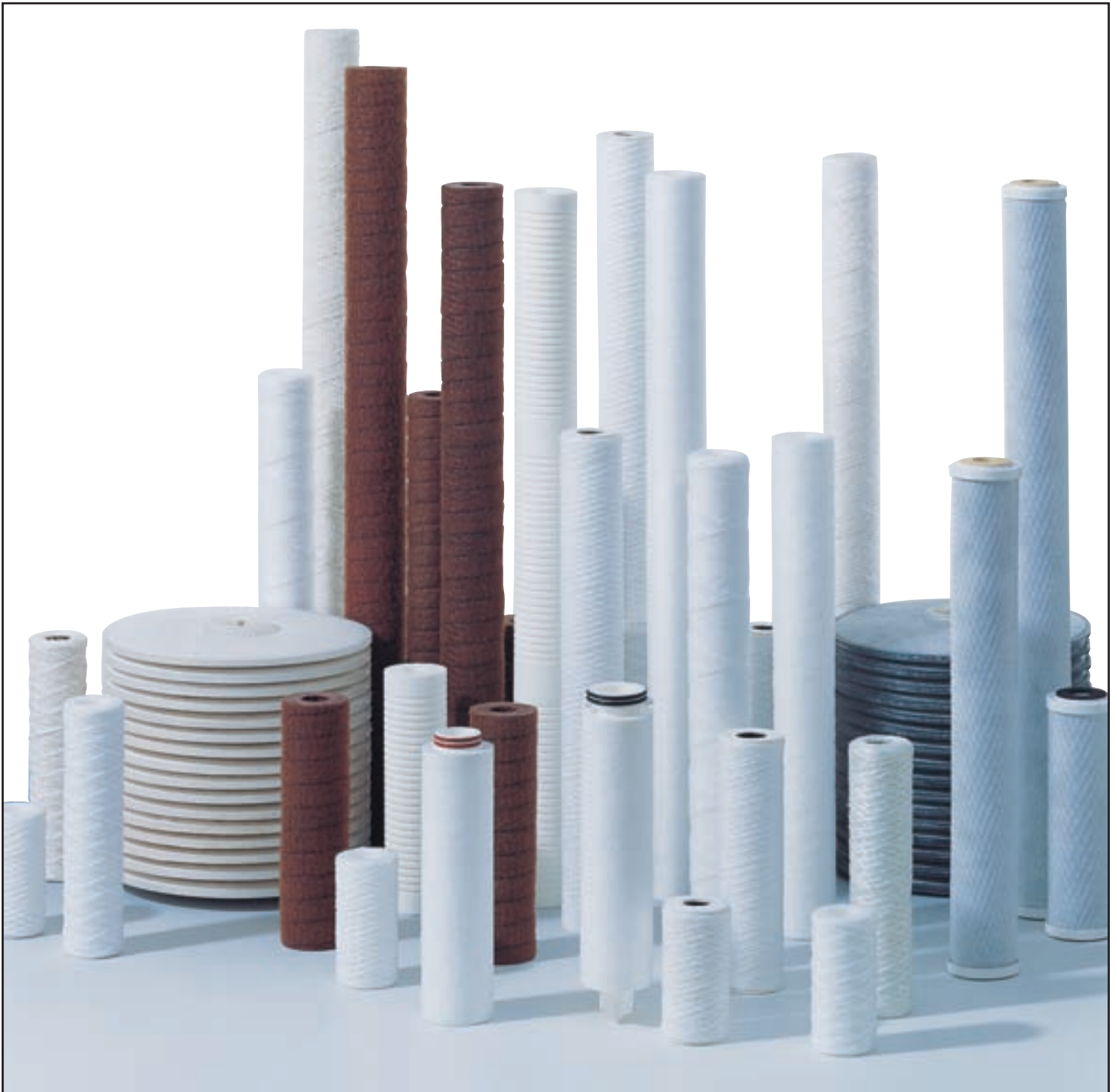

<b>LOFTOP</b>	Melt Blown Absolute-Rated Polypropylene Filter Cartridges	<b>Pages 4-6</b>
<b>LOFTREX</b>	Melt Blown Industrial Polypropylene Filter Cartridges	<b>Page 7</b>
<b>LOFWIND</b>	String Wound Filter Cartridges	<b>Page 8</b>
<b>LOFCLEAN</b>	Resin Bonded Acrylic Fiber Filter Cartridges	<b>Page 9</b>
<b>LOFSORB</b>	Extruded Carbon Filter Cartridges	<b>Page 10</b>
<b>LOFDISC</b>	Cellulose and Active Carbon Filter Modules	<b>Page 11</b>

# LOFTOP

The demand for industrial filtration continues to increase, driven by greater requirements for product purity. LOFTOP absolute filter cartridges are Eaton's response to these requirements. LOFTOP absolute filter cartridges have been developed for such demanding applications.

LOFTOP absolute filter cartridges are made of 100% high purity polypropylene micro fibers. Micro fibers are blown onto the center core. The meltblown process eliminates the requirement to use binders or additives.

LOFTOP absolute filter cartridges do not release any fibers.

## Typical Applications/Types of Usage:

### Pharmaceutical

Protection of membrane cartridges  
Filtration of extracts

### Electronic

Pure water, DI-water (pre-filtration),  
R. O. water (pre-filtration), photo resins,  
acids, bases

### Film and Photo

Photo resist resins, film lacquers, developer,  
emulsion, magnet dispersion

### Food and Beverages

Mineral water, beer, wine, fruit juice, milk,  
edible oils

### Cosmetics

Mouth wash, perfume, lotion, shampoo

### Automotive

E-coats

### Surface finishing

Coolants, plating liquids

### Others

Chemicals, paper coatings, printing inks, solvents, resins, lacquers, condensate recycling



### LOFTOP Absolute Filter Cartridges

- 100% pure Polypropylene
- No added adhesives
- Excellent chemical compatibility
- Biologically and chemically inert
- Controlled pore size
- Steam sterilization, autoclave
- Efficiency rating  $\beta$ -ratio 5000
- Open pore structure
- High structural stability
- High dirt load capacity
- No fiber release

### Technical Data:

Filter Fineness: 0.5 – 120  $\mu$ m

Length: 5" – 40"

Connections: DOE and O-ring adapter

Fiber Material:

Pure Polypropylene micro fibers manufactured according to FDA requirements (§ 177.152), thermally bonded on a Polypropylene core.

Temperature Resistance: 80°C permanent, (121°C steam sterilization)

Max. Differential Pressure: 4.0 bar/25°C

# β-RATIO 5000

## β-Value Efficiency Rating

**LOFTOP** absolute filter cartridges are subject to stringent quality control processes. They are regularly tested for their β-value.

The table below gives the filter efficiencies in μm at given β-values:

	β-5000	β-1000	β-100
LT-10-0,5-A	0.5	< 0.5	< 0.5
LT-10-1-A	1	0.5	< 0.5
LT-10-3-A	3	2	1
LT-10-5-A	5	4	3
LT-10-10-A	10	9	8
LT-10-20-A	20	18	15
LT-10-30-A	30	26	22
LT-10-50-A	50	40	31
LT-10-70-A	70	60	55
LT-10-90-A	90	80	77
LT-10-120-A	120	110	100

These results have been obtained according to OSU-F-2, ISO-4402 and ISO-4752 under laboratory conditions.

## Pressure Drop (ΔP)

The table below details the pressure drop-flow rate characteristics of LOFTOP cartridges flowing water at 20°C. Flow rate is stated as flow per 10" length. For fluids of other viscosities, multiply the indicated ΔP by the fluid viscosity in centipoise. The flow rate for multiple length cartridges is proportional, but should not exceed 4500 l/h.

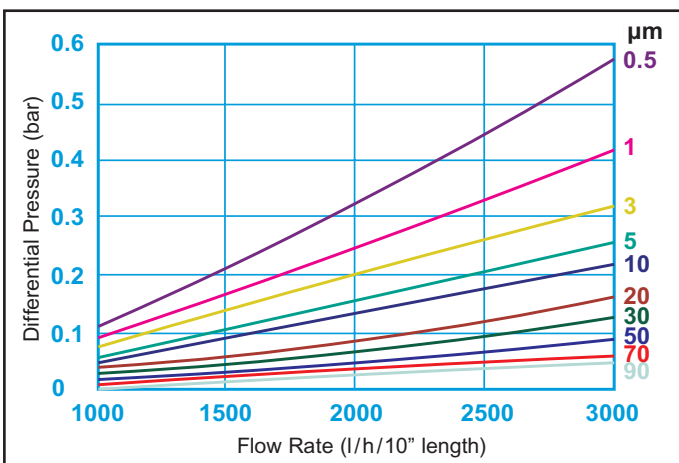

## Dirt Holding Capacity

**LOFTOP** absolute filter cartridges utilize a graded fibre structure capable of achieving high dirt loading characteristics.

The highest holding capacities are in the outer layers due to high pore volumes, preventing blinding of the cartridge surface.

	Dirt Holding Capacity (g/10")
LT-10-0,5-A	66
LT-10-1-A	68
LT-10-3-A	70
LT-10-5-A	70
LT-10-10-A	70
LT-10-20-A	70
LT-10-30-A	70
LT-10-50-A	70
LT-10-70-A	94
LT-10-90-A	360
LT-10-120-A	360

All tests were performed in water at 20°C with a flow rate of 7.5 l/min/10" length using coarse test dust at an inlet concentration of 1.2 g/l to a final ΔP of 2.7 bar. In other conditions, dirt capacity can vary significantly from these results.

## Recommended Flow Rates

Filtration efficiency and particle holding capacity are dependent on viscosity, filter efficiency and flow rate. For optimum results we recommend not to exceed the following flow rates (l/min/10" length):

	Viscosity in mPas			
	1 (H <sub>2</sub> O)	50	100	500
LT-10-0,5-A	8	1	0.6	-
LT-10-1-A	9	1.5	1	-
LT-10-3-A	10	2.5	1.8	1
LT-10-5-A	12	4	2.7	1.5
LT-10-10-A	14	8	5.4	3
LT-10-20-A	20	12	8	4
LT-10-30-A	30	14	9	4.3
LT-10-50-A	45	16	10	4.5
LT-10-70-A	50	18	11	5
LT-10-90-A	50	18	11	5
LT-10-120-A	50	18	11	5

# LOFTOP

**LOFTOP** absolute filter cartridges are available in a wide range of types for use in many different applications:

**Length:**

05" (127 mm)      30" ( 762 mm)  
 10" (254 mm)      40" (1016 mm)  
 20" (508 mm)

**Diameter:**

Outer Diameter: 64 mm  
 Inner Diameter: 27 mm





**Sealing Materials:**

Version G: Polypropylene  
 Version 2, 3+4: Silicone rubber (standard), Viton



**Choice of End Caps/Adapters:**

**LOFTOP** absolute filter cartridges come standard as DOE (double open end) versions with polypropylene flat gaskets (G). In addition they are available with common end caps/adapter with O-rings for Eaton cartridge housings and other systems. All end caps/adapters are made of polypropylene (FDA-conform).

DOE (standard) Polypropylene flat gaskets	DOE without flat gaskets	SOE 222 2 O-rings/ spear	SOE 226 2 O-rings/ bayonet spear	SOE 222 2 O-rings/ flat
				
<b>G</b>		<b>2</b>	<b>3</b>	<b>4</b>

**Optional Versions:**

For operating temperatures up to 100°C LOFTOP filter cartridges can be equipped with a stainless steel core.

Packaging Units:	
Length	05" = 60 pcs. 10" = 30 pcs. 20" = 15 pcs. 30" = 15 pcs. 40" = 15 pcs.
Box Sizes:	
Length	05" = 33 x 20 x 53 cm 10" = 33 x 20 x 53 cm 20" = 33 x 20 x 53 cm 30" = 33 x 20 x 78 cm 40" = 33 x 20 x 104 cm

**Product Code: LT - 10 - 30 - A - G**

**LOFTOP**

**Length (")**  
5 - 10 - 20 - 30 - 40

**Filter Fineness (µm)**  
0.5 - 1 - 3 - 5 - 10 - 20 - 30 - 50 - 70 - 90 - 120

**Absolute Efficiency β-ratio 5000**

**End Caps/Adapters:**  
 (not valid for DOE)  
 G (DOE foamed flat gaskets polypropylene)  
 2 (SOE 222 O-rings, spear)      2 V = with Viton O-rings  
 3 (SOE 226 O-rings, bayonet/spear)      3 V = with Viton O-rings  
 4 (SOE 222 O-rings/flat)      4 V = with Viton O-rings

**LOFTREX** filter cartridges are made of pure polypropylene (melt blown) micro fibers, thermally bonded to prevent any fibre migration.

**LOFTREX** filter cartridges do not contain an inner core.

**LOFTREX** filter cartridges comply with FDA requirements and are free of any binding agents.

**LOFTREX** filter cartridges are depth filters. They have a high pore volume and high dirt holding capacity.

**LOFTREX** filter cartridges are temperature resistant to 80°C. The polypropylene material offers excellent chemical compatibility.

### Applications Examples:

Water treatment, pure water pre-filtration, edible oils, fine chemicals, resins, reverse osmosis, DI water, sea water desalination, wine (pre-filtration), beverages, film development, fixing baths, solvents, cosmetics, galvanic baths.

### Technical Data:

Filter Fineness (nominal)	1-3-5-10-20-30-50-75 $\mu\text{m}$
Length:	5" - 40" (50" on request)
Inside Diameter:	28 mm
Outside Diameter:	64 mm
Max. Working Temperature:	80°C
Max. Differential Pressure:	2.5 bar at 30°C

### Pressure Drop ( $\Delta P$ )

The table below details the pressure drop-flow rate characteristics of LOFTREX cartridges flowing water at 20°C. Flow rate is stated as flow per 9 3/4" length. For fluids of other viscosities, multiply the indicated  $\Delta P$  by the fluid viscosity in centipoise.

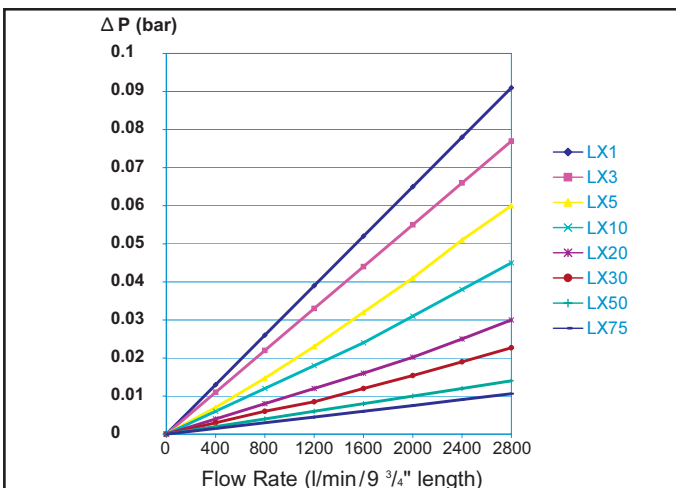

### Product Code: LX - 20 - 75

#### LOFTREX

#### Length

5	=	5"	(	127	mm)
9	=	9 3/4"	(	248	mm)
10	=	10"	(	254	mm)
19	=	19 1/2"	(	496	mm)
20	=	20"	(	508	mm)
29	=	29 1/4"	(	744	mm)
30	=	30"	(	762	mm)
39	=	39"	(	992	mm)
40	=	40"	(	1016	mm)
50	=	50"	(	1270	mm)

#### Filter Fineness ( $\mu\text{m}$ )

1 - 3 - 5 - 10 - 20 - 30 - 50 - 75

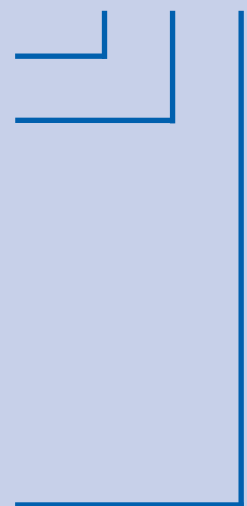

# LOFWIND

**LOFWIND** filter cartridges are string-wound depth filter elements.

**LOFWIND** filter cartridges can be used in many different types of applications due to the many different combinations of filter materials and inner cores.

## Applications:

Water treatment, sea water desalination, condensate preparation, process water, photo chemicals, film development, edible oils, solvents, galvanic baths, fats, acids, bases, chemical processes



### Technical Data:

Filter Fineness (nominal):	0.5 - 1 - 3 - 5 - 10 - 25 - 50 - 75 100 - 150 $\mu\text{m}$
Length:	5" - 40"
Inside Diameter:	28 mm
Outside Diameter:	62 mm
Max. Working Temperature:	80°C (Polypropylene) 160°C (Cotton) 400°C (Glass fiber)
Max. Differential Pressure:	2.5 bar / 30°C

**Max. Flow Rate**  
(Water flowing with  $\Delta P = 0.15$  bar/cartridge length 9 3/4")

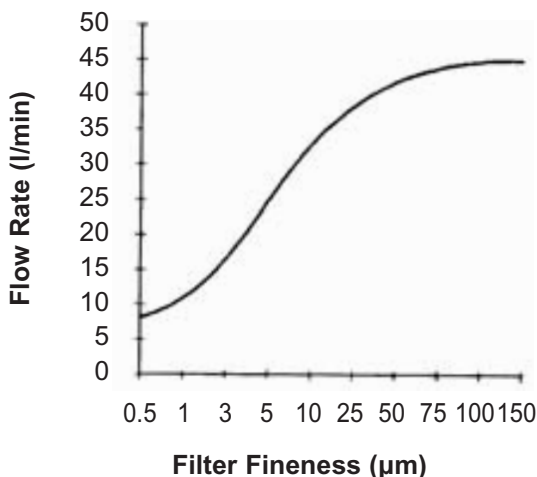

### Product Code:

**LOFWIND**

#### Length

5 = 5" ( 127 mm)
9 = 9 3/4" ( 248 mm)
10 = 10" ( 254 mm)
19 = 19 1/2" ( 496 mm)
20 = 20" ( 508 mm)
29 = 29 1/4" ( 744 mm)
30 = 30" ( 762 mm)
39 = 39" ( 992 mm)
40 = 40" (1016 mm)

#### Winding Material

B = bleached cotton
H = glass fiber, baked
P = Polypropylene
W = washed Polypropylene

#### Core

P = Polypropylene
S = stainless steel
T = tinned steel

#### Filter Fineness ( $\mu\text{m}$ )

0.5 - 1 - 3 - 5 - 10 - 25 - 50 - 75 - 100 - 150

**LW - 30 - B - S - 10**

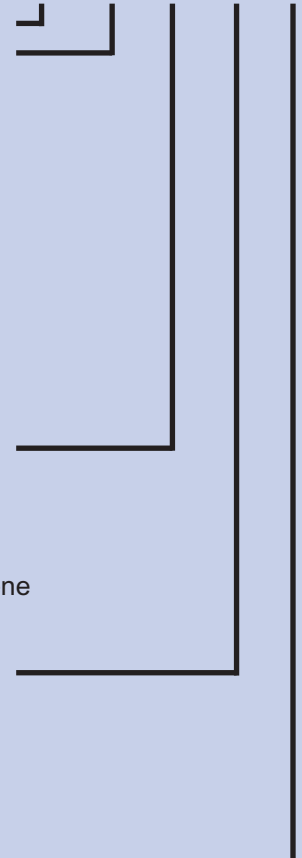



# LOFCLEAN

**LOFCLEAN** filter cartridges are resin bonded depth filter cartridges. They are made of long acrylic fibers, bonded with phenolic resins.

**LOFCLEAN** filter cartridges have no core and are self-stabilized by the phenolic resin.

**Applications:**

Lacquer, paints, printing inks, adhesives, resins, emulsions, petroleum, wax, process water, organic solvents, animal or vegetable fats, inks, low acids and bases (ph 5-9).

**Not recommended for oxidizing media and applications in the food industry.**



Technical Data:	
Material:	Acrylic fibres phenolic resin bonded
Filter Fineness (nominal):	2-5-10-25-50-75-125 150 µm
Length:	9 3/4" - 40"
Inside Diameter:	28 mm
Outside Diameter:	65 mm
Max. Working Temperature:	121°C
Max. Differential Pressure:	3.5 bar
Pressure Conditions:	10 bar/ 21°C 8.6 bar/ 38°C 6.2 bar/ 65°C 4.5 bar/ 82°C 1.7 bar/121°C
Viscosity:	max. 3250 mPas
Flow Rate (max.):	19 l/min per 9 3/4" length

Product Code: LC-20-A-125	
<b>LOFCLEAN</b>	
<b>Length</b>	
9 = 9 3/4" ( 248 mm)	
10 = 10" ( 254 mm)	
19 = 19 1/2" ( 496 mm)	
20 = 20" ( 508 mm)	
29 = 29 1/4" ( 744 mm)	
30 = 30" ( 762 mm)	
39 = 39" ( 992 mm)	
40 = 40" (1016 mm)	
<b>Material: Acryl</b>	
<b>Filter Fineness (µm)</b>	
2 - 5 - 10 - 25 - 50 - 75 - 125 - 150	

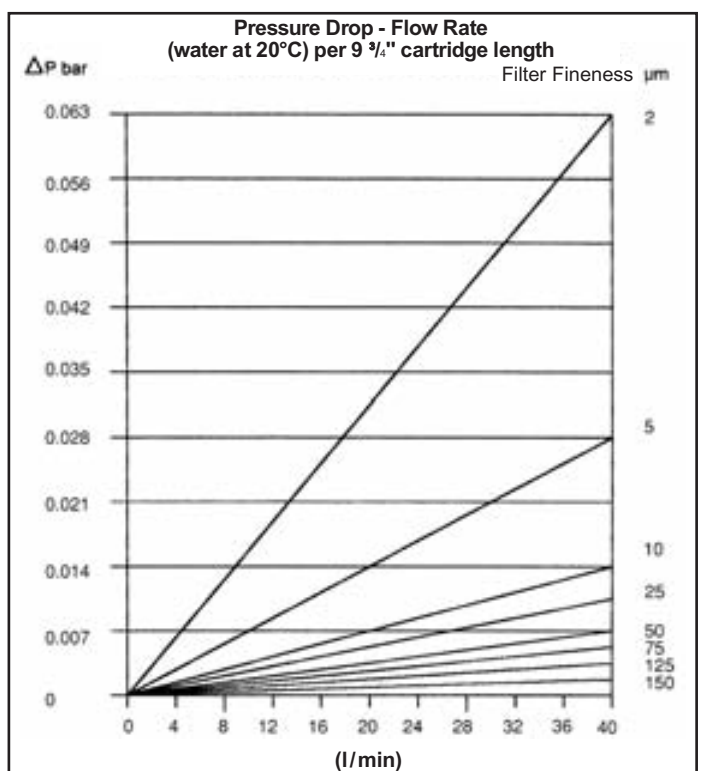

# LOFSORB

**LOFSORB** activated carbon cartridges are pressed and extruded under high pressure.

**LOFSORB** active carbon cartridges prevent carbon particles passing into the filtrate.

**LOFSORB** active carbon cartridges have excellent adsorption characteristics for chlorine and organic compounds.

## Applications:

Potable water, spirits, water based and organic solvents (removal of color, smell and taste contamination), galvanic baths (removal of organic contamination from nickel and copper baths).



Series 01 (04)

Series 02



## Technical Data:

	Type 01 (04)	Type 02
Filter Fineness:	1, 5 and 10 $\mu\text{m}$	5 $\mu\text{m}$
Efficiency:	95 %	95 %
Length:	4 $\frac{7}{8}$ , 9 $\frac{3}{4}$ , 20 and 30"	5, 9 $\frac{3}{4}$ , 10, 20 and 30"
Inside Diameter:	26 mm (01), 28 mm (04)	27 mm
Outside Diameter:	71 mm (01), 110 mm (04)	65 mm
Gaskets:	ENGAGE (Ethylene-octene copolymer)	Polypropylene
Max. Working Temperature:	52°C	52°C
Max. Differential Pressure:	7 bar	2.5 bar
Recommended Flow Rate (max.):	8 l/min per 9 $\frac{3}{4}$ " length	8 l/min per 9 $\frac{3}{4}$ " length
Activated Carbon:	85-90% coconut shell, 10-15% others	85-90% coconut shell, 10-15% others
Weight of Carbon:	4 $\frac{7}{8}$ " = 180 g 9 $\frac{3}{4}$ " = 360 g (type 04 = 1100 g) 20" = 720 g (type 04 = 2200 g) 30" = 1080 g	5" = 95 g 9 $\frac{3}{4}$ " + 10" = 190 g 20" = 380 g 30" = 570 g
Binder:	HDPE	HDPE
Outside:	Polypropylene fleece and net	washed Polypropylene yarn

Flow Rate (water, 20°C) per 9  $\frac{3}{4}$ " length

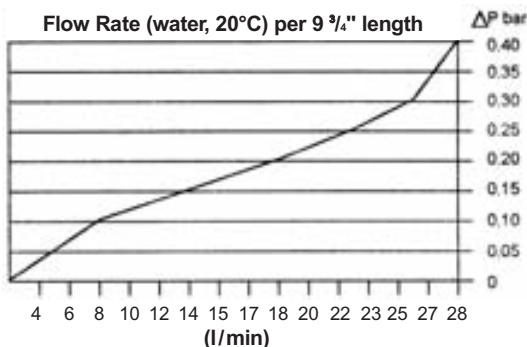

## Product Code: LA-9-E-3-01

LOFSORB

### Length

4 = 4  $\frac{7}{8}$ " (124 mm)  
5 = 5" (127 mm)  
9 = 9  $\frac{3}{4}$ " (248 mm)  
10 = 10" (254 mm)  
20 = 20" (508 mm)  
30 = 30" (762 mm)

### Type

01 = D 71 mm  
02 = D 65 mm  
04 = D 110 mm

### Fineness

1 = 1  $\mu\text{m}$   
2 = 5  $\mu\text{m}$   
3 = 10  $\mu\text{m}$

Extruded carbon

**Please note:** Due to the outside diameter of 71 mm, LOFSORB series 01 will not fit into the standard housing of the TOPCART series (from TKF-609 up). Special constructions are available upon request.

# LOFDISC

**LOFDISC** filter modules are used in closed systems, unlike filter sheets.

**LOFDISC** filter modules are made of either pure cellulose/diatomaceous earth filter sheets or activated carbon tintured sheets. Each module contains 16 single cells (standard). Each cell has a drainage system through which the liquid drains from outside to inside.

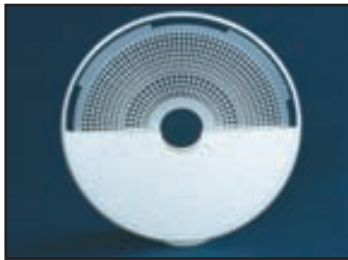

**LOFDISC** filter modules can be sterilized:

- In an autoclave at 121°C for 20 minutes.
- With steam (1 bar) for 20 minutes in a closed filter housing.
- Chemically, though not very common. A non oxidizing media must be applied if this method is used.

For wetting and removal of air and other particles, pre-washing of the filter unit (filter housing and module) with high purity water is necessary.

Cold water: 100 l per module through the system one time.  
Hot water: 20 l per module to be circulated for 30 minutes.

## Application examples:

Wine, beer, fruit juice, mineral water, beverages, pure water, pre-filter for protection of membrane filter systems, pharmaceutical, cosmetical and chemical products, lacquer

Technical Data and Materials:		
	Type 3AC	Type 4AC
Number of Cells:	16	16
Surface Area/Module:	1.8 m <sup>2</sup>	3.6 m <sup>2</sup>
Outside Diameter:	300 mm	400 mm
Inside Diameter:	50 mm	50 mm
Length:	275 mm	275 mm
Max. Operating Temperature:	80°C	80°C
Sterilization Temperature/Time:	121°C/20 min	121°C/20 min
Max. Differential Pressure:	2.5 bar	2.5 bar
pH Operating Range:	4 - 10	4 - 10
Filter Media (4 mm):	alpha grade cellulose and diatomaceous earth or activated carbon	
Filter Fineness:	0.2 - 35 µm	
Efficiency:	99.6%	
Support Skeleton:	Polypropylene (FDA 21 CFR 177.1520 and European Pharmacopoeia in accordance with paragraph 3.1.3 and 3.1.6)	
Metal Straps:	316 stainless steel	
Gaskets:	Silicone rubber (FPM on request)	
Scrim Cover:	Polypropylene	

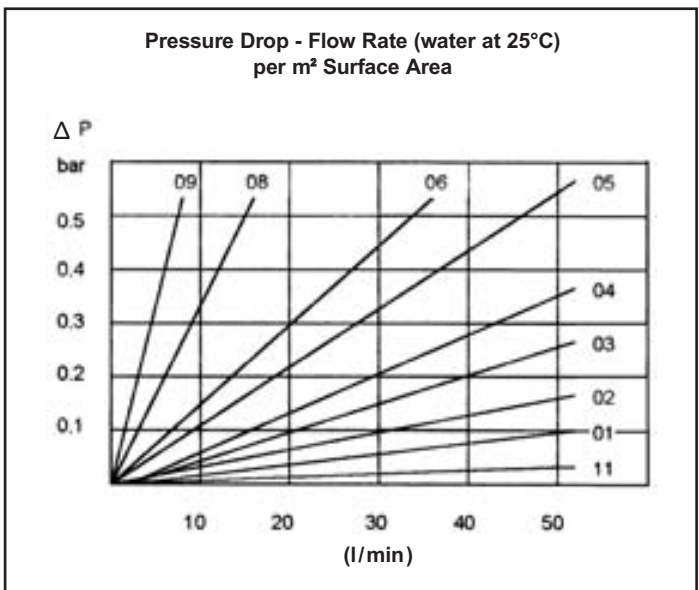

Product Code: 3 - AC - 16 - M 08 - S			3 - AC - 16 - AK 4 - AC - 16 - AK	
<b>Diameter outside</b> 3 = 300 mm 4 = 400 mm		<b>Scrim (cover)</b> (standard for 4-AC)	<b>Activated Carbon</b> — AK	
<b>Material</b> AC = alpha cellulose equipped		<b>Fineness (µm)</b> 09 = 0.05 - 0.2 08 = 0.2 - 0.4 06 = 0.4 - 0.6 05 = 0.5 - 0.8 04 = 0.6 - 1.5 03 = 1.5 - 3.0 02 = 4.0 - 9.0 01 = 10 - 25 11 = 15 - 35	Activated Carbon Modules are as standard with Scrim	
<b>Number of Cells</b>		<b>Weight of Carbon:</b> 3 - AC = 1200g 4 - AC = 2400g		
<b>Migration Disc</b> M = with fibre migration protection O = without fibre migration protection				

# CARTRIDGE FILTER HOUSINGS



**EKF „E“**



**EKF „BE“**



**PKF**



**TKF**



**EKF „E“**



**PCF**



**LDF**



**TKF**

## Cartridge Filter Housings

<b>ECOCART</b>	Single Cartridge Filter Housing <b>EKF "E"</b> and <b>EKF "BE"</b> Series	<b>Page 13</b>
	Multiple Cartridge Filter Housing <b>EKF "E"</b> Series	<b>Page 14</b>
<b>TOPCART</b>	Single Cartridge Filter Housing <b>TKF</b> Series	<b>Page 15</b>
	Multiple Cartridge Filter Housing <b>TKF</b> Series	<b>Page 16</b>
<b>POLYCART</b>	Single Cartridge Filter Housing <b>PKF</b> Series	<b>Page 17</b>
<b>POLYLINE</b>	Multiple Cartridge Filter Housing <b>PCF</b> Series	<b>Page 18</b>
<b>LOFDISC</b>	Module Filter Housing <b>LDF</b> Series	<b>Page 19</b>

The housings shown in this catalog are standard inventoried products constructed in compliance with the EU Pressure Equipment Directive 97/23/EC, Article 3, paragraph 3 with the working fluid classification as Group 2 (per Article 9, paragraph 2.2) and a liquid as defined in Article 3, paragraph 1.1 (b) for Group 2 fluids.  
For housings used in process applications that require compliance to other Pressure Equipment Directive criteria, please contact Eaton for price and availability.

**ECOCART (EKF) “E”** series cartridge filters are made for double open end (DOE) cartridges. Manufactured in SS 304, they consist of a head and a sump, connected by a center rod with a cap nut. Head and sump, as well as head and cap nut are sealed with flat ring gaskets.

The sump is equipped with a bottom drain. An optional bracket is available for mounting the filter to the wall.

**Technical Data:**

ECOCART Type	EKF-109-E	EKF-120-E	EKF-130-E
Max. Flow Rate (m <sup>3</sup> /h)	2.4	4.8	4.8
Max. Operating Conditions (bar/°C)	10/121	10/121	10/121
Housing Dimensions (mm)	A	349	603
	B	281	535
	C	105	105
Volume (l)	1.47	2.9	4.4
Weight (kg)	3.5	4.5	5.5
Inlet/Outlet (BSP female)	1"	1"	1"
Drain (NPT female)	3/16"	3/16"	3/16"
Length of Filter Cartridge	9 3/4" = 248 mm	20" = 508 mm	30" = 762 mm
No. of Filter Cartridges	1	1	1
Max. Cartridge Outside Diameter	72 mm	72 mm	72 mm



Series EKF “E”

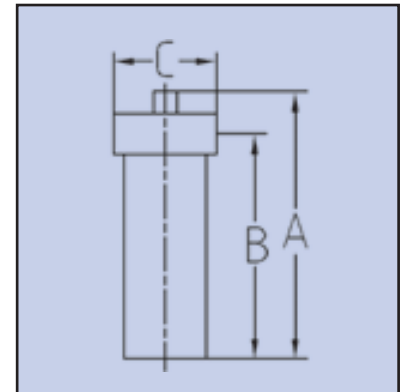

**ECOCART “BE”** series cartridge filters are made of brass (head and union nut) and SS 304 (sump) for the use with DOE filter cartridges. The union nut is pulled over the sump and screwed to the head. The sump and head are sealed by a NBR head O-ring. The O-ring can also be supplied in FPM. An optional bracket is available for wall mounting.

**Technical Data:**

ECOCART Type	EKF-109-BE-3/4 EKF-109-BE-1	EKF-120-BE-3/4 EKF-120-BE-1
Max. Flow Rate (m <sup>3</sup> /h)	2.4	4.8
Max. Operating Conditions (bar/°C)	17/121	17/121
Housing Dimensions (mm)	A	337
	B	317
	C	114
Volume (l)	1.5	2.97
Weight (kg)	3.5	4.5
Inlet/Outlet (BSP female)	3/4" or 1"	3/4" or 1"
Drain (NPT female)	1/8"	1/8"
Length of Filter Cartridge	9 3/4" = 248 mm	20" = 508 mm
No. of Filter Cartridges	1	1
Max. Cartridge Outside Diameter	72 mm	72 mm



Series EKF “BE”

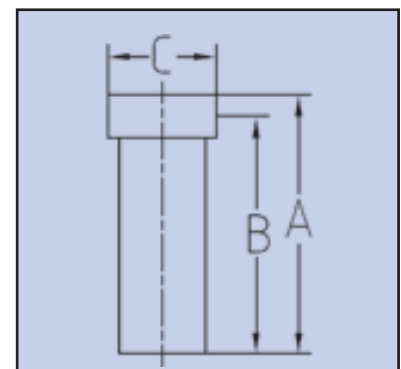

# ECOCART

**ECOCART** cartridge filter housings (EKF) are made in a lightweight SS 304 construction for use with standard DOE filter cartridges. The housings feature a V-clamp closure sealing with an NBR O-ring. FPM is available as an option.

**ECOCART** cartridge filters are manufactured as self-supporting versions (500 series) or with legs (1200 series and larger). To mount a gauge or a vent to the housing, the lids are equipped with  $\frac{1}{4}$ " BSP female ports.

There are  $\frac{1}{2}$ " BSP drains for clean and dirt-drain in the lower part of the housing.

All filter cartridges (DOE style) are secured by means of a hold down plate tightened with a center rod/bolt.

**ECOCART** cartridge filter housings are suitable for all standard DOE (double open end) cartridges, with a maximum outside diameter of 71 mm.



Serie EKF-E



## Technical Data:

ECOCART Type	EKF-	509-E	520-E	530-E	540-E	1220-E	1230-E	1240-E	2230-E	2240-E
Max. Flow Rate (m <sup>3</sup> /h)		8.4	16.8	25.2	33.6	40.2	60	80.4	110.4	147
Max. Pressure Conditions (bar/C°)		10/121								
Housing Dimensions (mm)	A	502	755	1010	1264	1003	1257	1511	1232	1486
	B	175				391			386	
	C	267				413			527	
	D	76				241			238	
Volume (l)		14	23	31	38	51	69.2	87.4	123	155.3
Weight (kg)		13	16	19	22	41	50	62	66	75
Inlet/Outlet		BSP-female thread 2"				DIN flange DN80 PN 16			DIN flange DN100 PN 16	
Drain		BSP female $\frac{1}{2}$ "								
Length of Filter Cartridge (")		9 $\frac{3}{4}$ / 10	19 $\frac{1}{2}$ / 20	29 $\frac{1}{4}$ / 30	39 / 40	19 $\frac{1}{2}$ / 20	29 $\frac{1}{4}$ / 30	39 / 40	29 $\frac{1}{4}$ / 30	39 / 40
No. of Filter Cartridges		5				12			22	
Max. Cartridge Outside Diameter		71 mm				71 mm			71 mm	

# TOPCART

**TOPCART** single cartridge filter housings (TKF) are made of high quality SS 316. The housings have a head and sump. They are opened and closed with a Tri-Clamp ring. The head is electro-polished; the sump is mechanically polished.

The head inlet and outlet (1" BSP threaded connection) are positioned in-line. The housing is equipped with a vent in the head (1/4" BSP threaded connection) and a drain in the sump (3/8" BSP). The housing is sealed with a NBR O-ring. FPM O-rings are available as an option.

**TOPCART** single cartridge filters are made for the use with 9 3/4", 10", 20" and 30" cartridges. The housings can be supplied for use with DOE-, SOE-222 and SOE-226 filter cartridges.



Series TKF-100

**For DOE Filter Cartridges:**

TKF-110-S; TKF-120-S; TKF-130-S

**For SOE 222 Filter Cartridges:**

TKF-110-S-222; TKF-120-S-222; TKF-130-S-222

**For SOE 226 Filter Cartridges:**

TKF-110-S-226; TKF-120-S-226; TKF-130-S-226

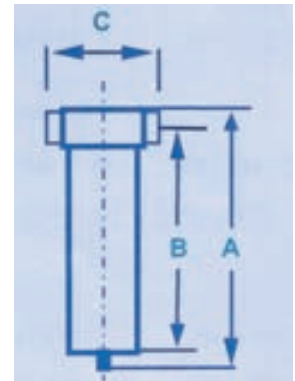

**Technical Data:**

TOPCART Type	TKF-110-S TKF-110-S-222 TKF-110-S-226	TKF-120-S TKF-120-S-222 TKF-120-S-226	TKF-130-S TKF-130-S-222 TKF-130-S-226
Max. Flow Rate (m³/h)	2.4	4.8	4.8
Max. Operating Conditions (bar/°C)	20/121	20/121	20/121
Housing Dimensions (mm)	A	354/354/398	604/604/649
	B	316/316/360	566/566/611
	C	120	120
Volume (l)	1.7	3.23	4.66
Weight (kg)	3	4	5.6
Inlet/Outlet	1"	1"	1"
Drain	3/8"	3/8"	3/8"
Length of Filter Cartridge	9 3/4"/10" = 248/254 mm	20" = 508 mm	30" = 762 mm
No. of Filter Cartridges	1	1	1
Max. Cartridge Outside Diameter	72 mm	72 mm	72 mm

# TOPCART

**TOPCART** multiple cartridge filters are heavy-duty standard filter housings designed for industrial liquid filtration. They are made of either stainless steel (SS 316) or special materials such as Hastelloy for 6 to 73 standard filter cartridges in 9 3/4" to 40" in length.

These filters feature a variety of different options including flat or spherical covers, clamp screws or swing-eye bolts, loose covers or davits (manual or hydraulic), side entry and central bottom outlet. The cover is sealed with an NBR-O-ring. FPM O-rings are available as an option. All filters are equipped with a cover vent and a drain in the bottom plate.

Heating jackets are available for all **TOPCART** multiple filter housings. Further modifications are available upon request.



**TOPCART** cartridge filters are ready to be used with standard DOE filter cartridges, with SOE-222 cartridges (standard) or with SOE-226 cartridges (special).

On request, manufacturing can be made in accordance with a notified body approval (CE certification according to PED 97/23/EC).

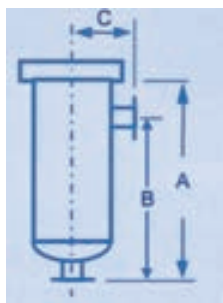

**Type Code: TKF-620-S-M**

**TOPCART Cartridge Filter** \_\_\_\_\_

**No. of Filter Cartridges** \_\_\_\_\_

**Length of Filter Cartridges** \_\_\_\_\_

09 = 9 3/4" ( 248 mm)  
 20 = 20" ( 508 mm)  
 30 = 30" ( 762 mm)  
 40 = 40" (1016 mm)

**Design Code**  
i.e. type of lid / closure

**Material of Construction**  
S = SS 316  
H = HASTELLOY

**Max. Cartridge Outside Diameter: 70 mm**

## Technical Data:

TOPCART Type	TKF-609-S to TKF-640-S	TKF-1120-S to TKF-1140-S	TKF-1920-S to TKF-1940-S	TKF-3720-S to TKF-3740-S	TKF-7330-S to TKF-7340-S		
Max. Operating Conditions (bar/°C)	10/160	10/121					
Construction Materials	SS 316 or special material (e.g. HASTELLOY) on request						
Filter Connections (N1/N2)	DN 50	DN 80	DN 100	DN 150	DN 150		
Lid Type	flat loose cover	flat loose cover	flat davit construction	spherical davit construction	spherical davit construction		
Lid Closure	swing eye-bolts	studs, hex. bolts/nuts	studs, hex. bolts/nuts	segment clamps screws			
Max. Flow Rate (m³/h)	Length of Filter Cartridge	9 3/4"	9	—	—	—	
		20"	18	33	57	111	—
		30"	27	50	86	167	328
		40"	36	66	115	222	438
Approx. Dimensions (mm) A/B/C	Length of Filter Cartridge	9 3/4"	490 / 410 / 220	700 / 500 / 265	735 / 525 / 305	795 / 595 / 380	—
		20"	735 / 665 / 220	945 / 745 / 265	980 / 770 / 305	1040 / 840 / 380	1115 / 925 / 500
		30"	985 / 905 / 220	1195 / 995 / 265	1230 / 1020 / 305	1290 / 1090 / 380	1365 / 1175 / 500
		40"	1230 / 1150 / 220	—	—	—	—
Approx. Housing Weight (kg) / Volume (l)	Length of Filter Cartridge	9 3/4"	43 / 14	—	—	—	
		20"	47 / 24	76 / 51	118 / 85	200 / 210	—
		30"	51 / 31	82 / 73	129 / 120	221 / 270	562 / 405
		40"	55 / 44	88 / 93	140 / 150	242 / 330	605 / 530



# POLYCART

**POLYCART** cartridge filter housings are single cartridge filters constructed of plastic for (DOE) standard cartridges in 4 7/8" to 20".

The housings are available in two styles with different diameters: 122 and 185 mm:

The 122 mm model (Series K) is available in either polypropylene alone or with a polypropylene head and a transparent sump (SAN).

The 185 mm model (Series G) works with cartridges up to a diameter of 114 mm.

The head inlet and outlet (N1/N2) are positioned in-line. They are available in sizes 3/8" up to 1 1/2" BSP threaded connection, depending on housing style (see technical data).

An NBR O-ring seals cover and sump. FPM O-rings are available as an option.



Series PKF



Key



Mounting Bracket

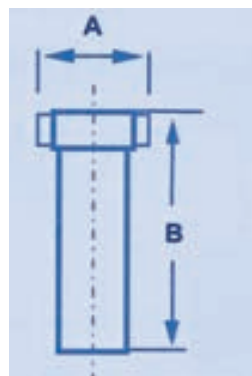

## Type Code

### PKF-1-05-K-P-3/8-E

No. of Filter Cartridges	1
Length of Filter Cartridges	5
Design	K= ø 122 mm G= ø 185 mm
Material of Construction	P= Polypropylene T= transparent SAN
N1/N2 (")	3/8 3/4 1 1 1/2
Vent (optional)	E

## Technical Data:

POLYCART Type	PKF-	1-05-K-P	1-05-K-T	1-09-K-P	1-09-K-T	1-20-K-P	1-09-G-P-E	1-20-G-P-E
Max. Operating Conditions (bar/°C)	8/50							
Filter Connections (N1/N2) BSP Female Thread (")		3/8 or 3/4	3/8 or 3/4	3/8 / 3/4 / 1	3/8 / 3/4 / 1	3/4 or 1	1 1/2	1 1/2
Measure A (mm)	122						185	
Measure B (mm)		175/190	175/190	295/310/310	295/310/310	575/575	350	620
Length of Filter Cartridges (")		4 7/8	4 7/8	9 3/4	9 3/4	20	9 3/4	20
Max. Cartridge Outside Diameter	72 mm						114 mm	
Material Filter Head	Polypropylene							
Material Filter Sump		Polypropylene	SAN	Polypropylene	SAN	Polypropylene	Polypropylene	Polypropylene
Vent	optional						yes	
Key (optional)	PKF-K-S						PKF-G-S	
Wall Mounting Bracket (optional)	PKF-K-W						PKF-G-W	

# POLYLINE

**POLYLINE** multiple cartridge housings are heavy-duty filter housings made of glass-reinforced polypropylene. These housings are made in one piece without any welds. All inserts are also molded in one piece, free of welds.

The housing can fit five filter cartridges of 30" length. Cartridges to be used can be DOE (double open end) or SOE 222 (with double O-ring).

The cover is screwed onto the housing sealed with an FPM O-ring. The cover features a vent as standard.

The housing is equipped with an inlet (N1) and two outlets (N2) for in-line or loop piping connections. The unused outlet can either be plugged or can be used as a drain.

The filter housing is supplied with either 2" BSP female connections or 2" ANSI/DIN flanges.

The filter housing has a self-supporting integral bottom mounting flange. It can be bolted in the floor for additional security. No additional leg assembly is needed.

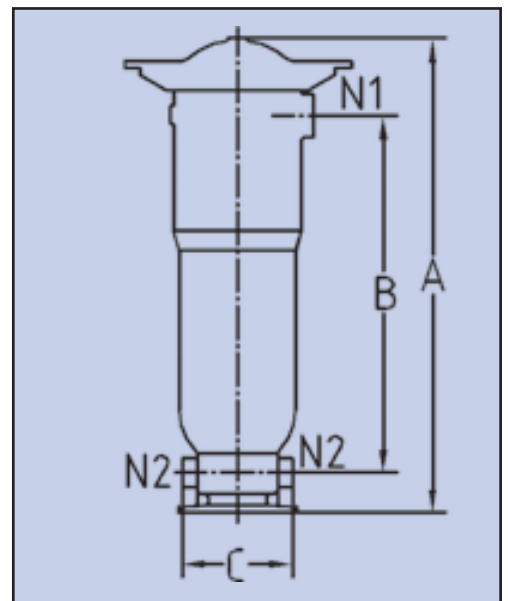
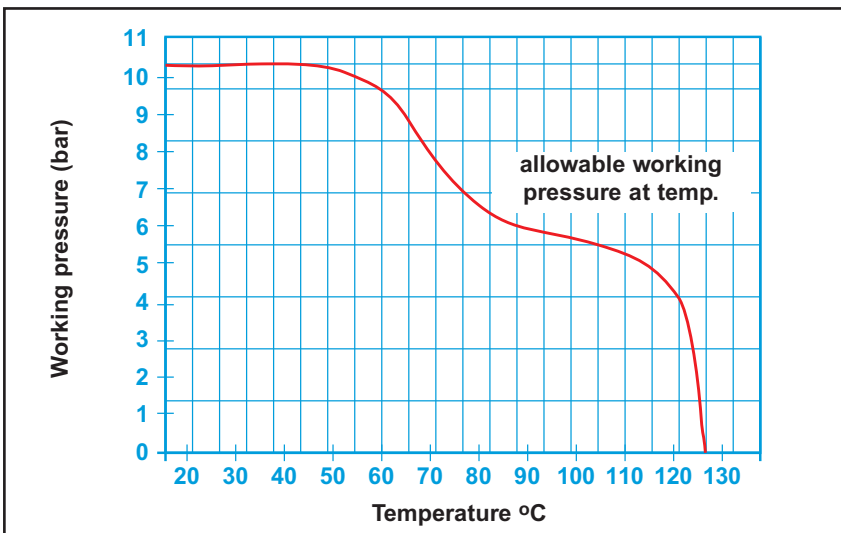

## Technical Data:

POLYLINE Type	PCF-530-P-10	PCF-530-P-10-F
Max. Operating Conditions (bar/°C)	10/20 (see graph)	
Material	glass-reinforced Polypropylene	
Housing Dimensions (mm)	A	1221
	B	930
	C	330
Volume (l)	36	
Vent	5/8" NPT	
Length of Filter Cartridge	30" (= 762 mm)	
No. of Filter Cartridges	5	
Max. Cartridge Outside Diameter	70 mm	
Weight (kg)	30	32
Inlet/Outlet	2" BSP female thread	2" ANSI/DIN flange

**LOFDISC** module filter housings are constructed with a variety of diameters and heights. They are available with either an industrial finish (glass bead blasted or brushed) or a sanitary finish (electro-polished).

The standard housing is made for operating conditions of 10 bar/121°C.

The closing mechanism operates with a V-clamp or clamp screws.

The housings (standard) are equipped with 1-1/2" Tri-Clamp (series 3AC) or 2" Tri-Clamp (series 4AC) connections. They can be supplied with flanges, dairy or sanitary connections.

The filter modules are placed over the central rod and fixed to the housing bottom plate. The filter housing is sealed with an adjustable top screw pressing the top down onto the bottom plate.



LDF-3AC-316-S-N

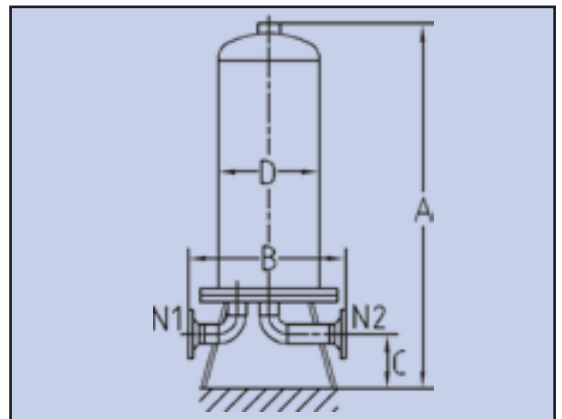

Type Code	LDF - 3AC - 4 16 - I - M
LOFDISC Filter Housing	
Housing Diameter	
3 = for 300 mm Filter Module	
4 = for 400 mm Filter Module	
No. of Modules	
1,2,3 or 4 Modules	
No. of Filter Cells	
16 = 16 Filter Cells (standard)	
Surface Finish	
I = Industrial Finish	
S = Sanitary Finish	
Code for All Modifications	

LOFDISC Housing Type	Dimensions (mm)				N1/N2	Weight (kg)	Volume (liter)	Filter area (m <sup>2</sup> )	Flow rate* (m <sup>3</sup> /h)
	A	B	C	D					
LDF-3AC-116-I	730	440	210	324	1 1/2"	34	29	1.8	2.5
LDF-3AC-216-I	1030	440	210	324	1 1/2"	40	53	3.6	5
LDF-3AC-316-I	1390	440	210	324	1 1/2"	48	81	5.4	7.5
LDF-3AC-416-I	1710	440	210	324	1 1/2"	58	108	7.2	10
LDF-4AC-116-I	750	640	210	450	2"	75	60	3.6	5
LDF-4AC-216-I	1050	640	210	450	2"	85	106	7.2	10
LDF-4AC-316-I	1410	640	210	450	2"	97	162	10.8	15
LDF-4AC-416-I	1730	640	210	450	2"	105	214	14.4	20

\* max. recommended flow rate for water bases liquids (Viscosity ≥ 1mPas)

**Eaton Technologies GmbH  
Filtration Division  
Nettersheim Branch**

Auf der Heide 2  
53947 Nettersheim, Germany  
tel.: +49 2486 809 0  
fax: +49 2486 809 800  
e-mail: [info-filtration@eaton.com](mailto:info-filtration@eaton.com)  
[www.eaton.com/filtration](http://www.eaton.com/filtration)

**Eaton Technologies GmbH  
Filtration Division  
Bron Branch**

La Tour Sier,  
129 boulevard Pinel  
69500 Bron, France  
tel.: +33 4 72 78 84 50  
fax: +33 4 78 74 43 07  
e-mail: [info-filtration@eaton.com](mailto:info-filtration@eaton.com)  
[www.eaton.fr/filtration](http://www.eaton.fr/filtration)

**Eaton Technologies GmbH  
Filtration Division  
Headquarters EMEA**

Dr.-Reckeweg-Str. 1  
76532 Baden-Baden, Germany

**Customer Service EMEA**

Austria	tel.: 0800 29 36 89
Belgium	tel.: 0800 77 0 22
France	tel.: +33 472 78 84 50
Germany	tel.: +49 2486 809 400
Italy	tel.: 800 78 58 83
Luxembourg	tel.: 800 2 42 98
Netherlands	tel.: 0800 0 22 27 03
Spain	tel.: 900 98 49 15
UK	tel.: +44 1206 848 350
Export	tel.: +49 2486 809 470

tel.: 0800 29 36 90
fax: 0800 77 0 23
fax: +33 4 78 74 43 07
fax: +49 2486 809 500
fax: 800 78 58 84
fax: 800 2 42 99
fax: 0800 0 22 26 95
fax: 900 98 49 14
fax: +44 1206 848 359
fax: +49 2486 809 570

**North America**

Eaton Filtration, LLC  
70 Wood Avenue, 2nd Floor  
Iselin, NJ 08830,  
USA  
tel.: +1 800 859 9212  
fax: +1 952 906 3706  
e-mail: [filtrationinfo@eaton.com](mailto:filtrationinfo@eaton.com)  
[www.eaton.com/filtration](http://www.eaton.com/filtration)

**Asia**

Eaton Filtration (Shanghai) Co.,Ltd.  
No. 3 Lane 280 Linhong Rd Changning  
District Shanghai 200335 China  
tel.: +86-21-52000422  
Fax: +86-21-52000400  
e-mail: [filtrationinfo@eaton.com](mailto:filtrationinfo@eaton.com)  
[www.eaton.com/filtration](http://www.eaton.com/filtration)

**South America**

Eaton Ltda.  
Av. Julia Gaioli, 474-Bonsucesso  
07251-500 - Guarulhos  
Brazil  
tel.: +55 11 2465 8822  
fax: +55 11 2465 8884  
e-mail: [filtration\\_br@eaton.com](mailto:filtration_br@eaton.com)  
[www.eaton.com/filtration](http://www.eaton.com/filtration)

GAF®, the GAF® logo, ACCU-GAF™, DURAGAF™, PROGAF™ and GAF SNAP-RING® are registered trademarks of GAF Corporation in the United States and are used under license.  
To the best of our knowledge, although not binding for us, all stated information is correct.